

MAE Flameproof Alternator 15 Standard 24V 400W

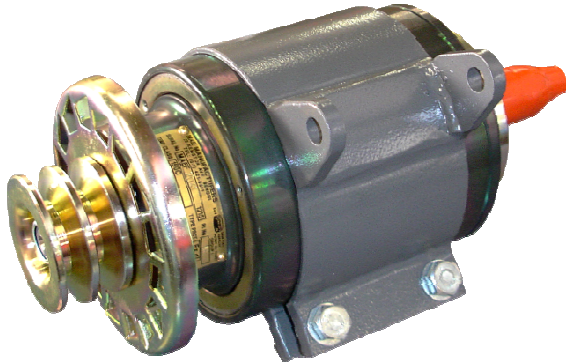

PART NO: MAEF002415



• Product Features

- ❖ Flameproof & dust proof.
- ❖ 12 and 24 Volts configurations available.
- ❖ Max 400W.
- ❖ Self-exciting.
- ❖ Various pulley configurations available.
- ❖ Internal short circuit protection cut-out device.
- ❖ Indicator charge pilot light.
- ❖ Various cable entries back covers available.
- ❖ IA certification.

• Technical Specifications

Max Output Power	400W
Output Voltage	24V
Certificate	M-XPL_15.0216X (IECEx) SIRA 02ATEX1255(ATEX) IP68
Min Alternator Speed	1500 RPM
Max Alternator Speed	12000 RPM
Weight	13kg
Overall Length	258mm
Overall Diameter	133mm

NOTE

To request a detailed Technical Specification Datasheet please contact admin@maesa.co.za

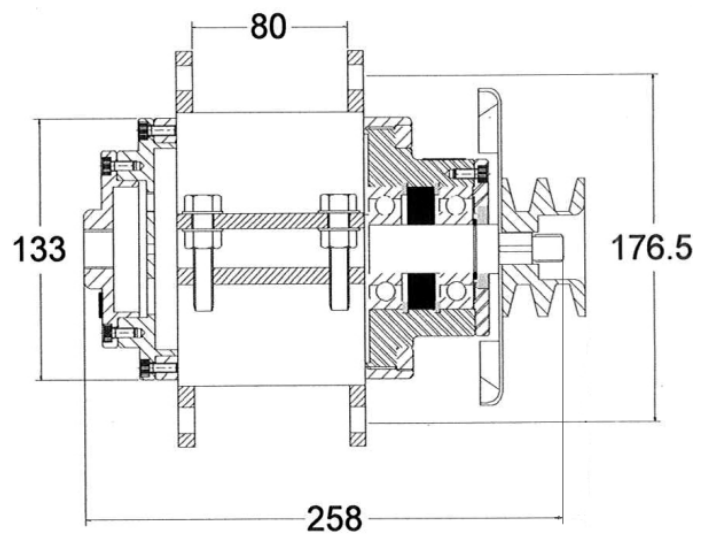

M-003-15-03

MAE Flameproof Alternator 15 Standard 24V 400W

M-003-15-03-FS-04

16 June 2017

Page 1 of 2

• Application

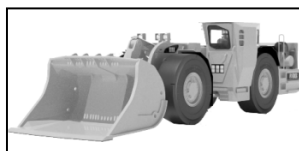

LHD LOADER

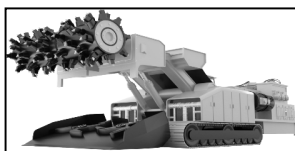

CONTINUOUS

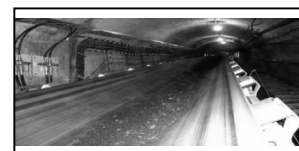

HAULAGE



LHD DUMP TRUCK

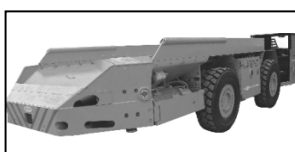

SHUTTLE CAR



GENERAL MINING VEHICLES

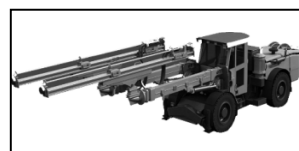

DRILLS



LONGWALL SHIELD

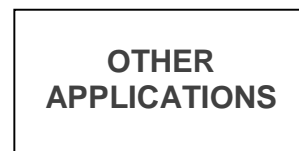

**OTHER
APPLICATIONS**



• Summary

The MAE Flameproof Alternator (24V 400W) is compact and robust in design, with low maintenance required and is suitable for hazardous environment zone **Ex d I Mb**.

This alternator is certified with the following global approvals:

- ❖ ATEX (Europe) SIRA
- ❖ IECEX (South Africa) EXPLOLABS

• Disclaimer

The information in this specification is derived from the latest model available at the time of issue 1.0. While every precaution has been taken to ensure the accuracy of the content, no responsibility can be accepted for any errors or omissions nor any misinterpretation or misapplication. MAE has adopted a continuous product improvement policy and therefore, specifications are subject to change without prior notice © September 2009 MAE all rights reserved.

Address: 23 Kemston Avenue,
Benoni
1501
Gauteng
South Africa

Tel: +27 011 421 5551
Fax: +27 011 421 5618
Email: orders@maesa.co.za
admin@maesa.co.za
sales@maesa.co.za

M-003-15-03

MAE Flameproof Alternator 15 Standard 24V 400W