

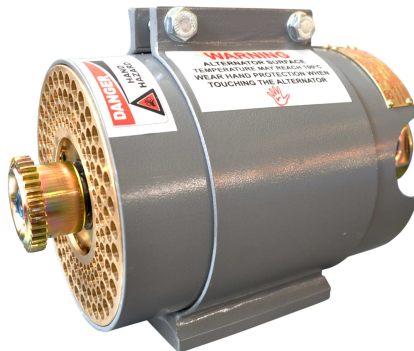

MAE Flameproof Alternator 4X Status 12V 300W

PART NO: MAEF001215/4X

• Product Features



- ❖ Flameproof & dust proof.
- ❖ 12 and 24 Volts configurations available.
- ❖ Dual power output (on request) available.
- ❖ Max 300W
- ❖ Self-exciting.
- ❖ Error detecting and lock-out protections.(See Datasheet)
- ❖ Error Logs recorded.
- ❖ Communications IR interface. (MAEIR Handheld)
- ❖ Indicator charge pilot light.
- ❖ Various pulley configurations available.
- ❖ Fan Protection guard: IP10 and IP20.
- ❖ Various cable entries back covers available.
- ❖ IA certification.

• Technical Specifications

Max Output Power	300W
Output Voltage	13,7V
Certificate	M-XPL_15.0216X (IECEX) SIRA 02ATEX1255(ATEX) IP68
Min Alternator Speed	1500 RPM
Max Alternator Speed	12000 RPM
Weight	13kg
Overall Length	258mm
Overall Diameter	164mm

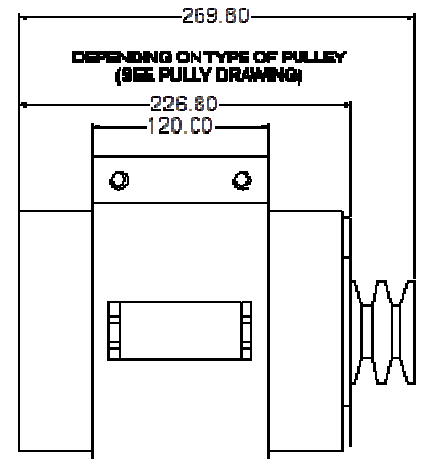
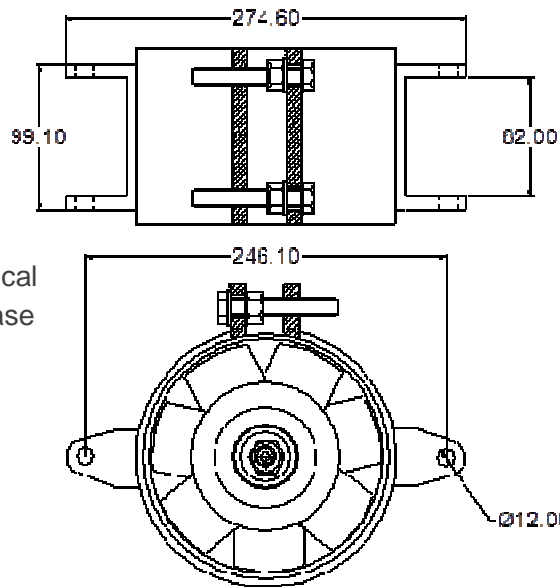

NOTE

To request a detailed Technical Specification Datasheet please contact admin@maesa.co.za

• Application

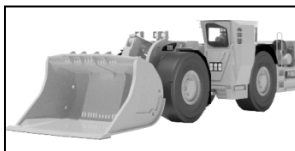

LHD LOADER

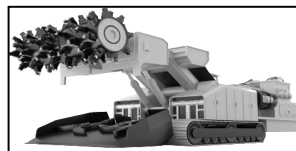

CONTINUOUS



HAULAGE



LHD DUMP TRUCK

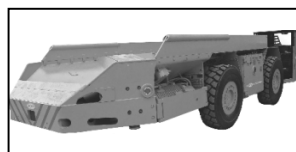

SHUTTLE CAR



GENERAL MINING VEHICLES

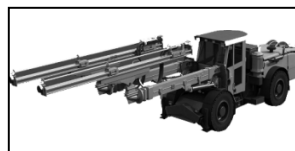

DRILLS



LONGWALL SHIELD

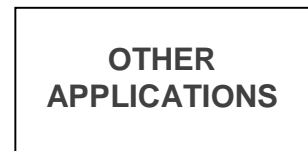

OTHER APPLICATIONS



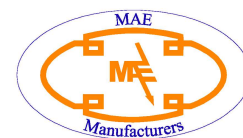

• Summary

The MAE 4X Flameproof Alternator (300W 12V) incorporates a log error detection-lockout protection system. It is compact and robust in design, with low maintenance required and is suitable for hazardous environment zone **Ex d I Mb**.

This alternator is certified with the following global approvals:

- ❖ TÜV (Australia)
- ❖ IECEX (South Africa) EXPLOLABS

• Disclaimer

The information in this specification is derived from the latest model available at the time of issue 1.0. While every precaution has been taken to ensure the accuracy of the content, no responsibility can be accepted for any errors or omissions nor any misinterpretation or misapplication. MAE has adopted a continuous product improvement policy and therefore, specifications are subject to change without prior notice © September 2009 MAE all rights reserved.

Address: 23 Kemston Avenue,
Benoni
1501
Gauteng
South Africa

Tel: +27 011 421 5551
Fax: +27 011 421 5618
Email: orders@maesa.co.za
admin@maesa.co.za
sales@maesa.co.za

M-003-16-01

MAE Flameproof Alternator 4X Status 12V 300W