



MAE Flameproof LED Headlight

PART NO: MAEFLD

• Product Features



- ❖ Flameproof & dust proof.
- ❖ Vibration resistant.
- ❖ Base mount or side mount available.
- ❖ Dimmable
- ❖ Dual programmable multi-colour switching centre light.(See Datasheet)
- ❖ Communications IR interface. (MAEIR Handheld)
- ❖ Durable LED Lamp: long life expectancy.
- ❖ Beam angle: 10 degree. (spot beam)
- ❖ Colour temperature: 4000K.
- ❖ Colour rendering index: (CRI) 70.
- ❖ Colour: neutral white.
- ❖ Luminous flux: 300 lux @ 10m.
- ❖ M25 cable entries - RSA: 2.
- ❖ M20 cable entries - AUS: 2.
- ❖ IA certification

• Technical Specifications

Power Consumption	11W @ 13,7V
Input Voltage	9 – 45 V (AC or DC)
Certificate	MASC M/13-644X (RSA)IECEX ANZEx 14.4135X (AUS) CML 14 ATEX 1022 (EUROPE)
Weight	4,5kg
Overall Length	140mm
Overall Width	152mm
Overall Height	91mm

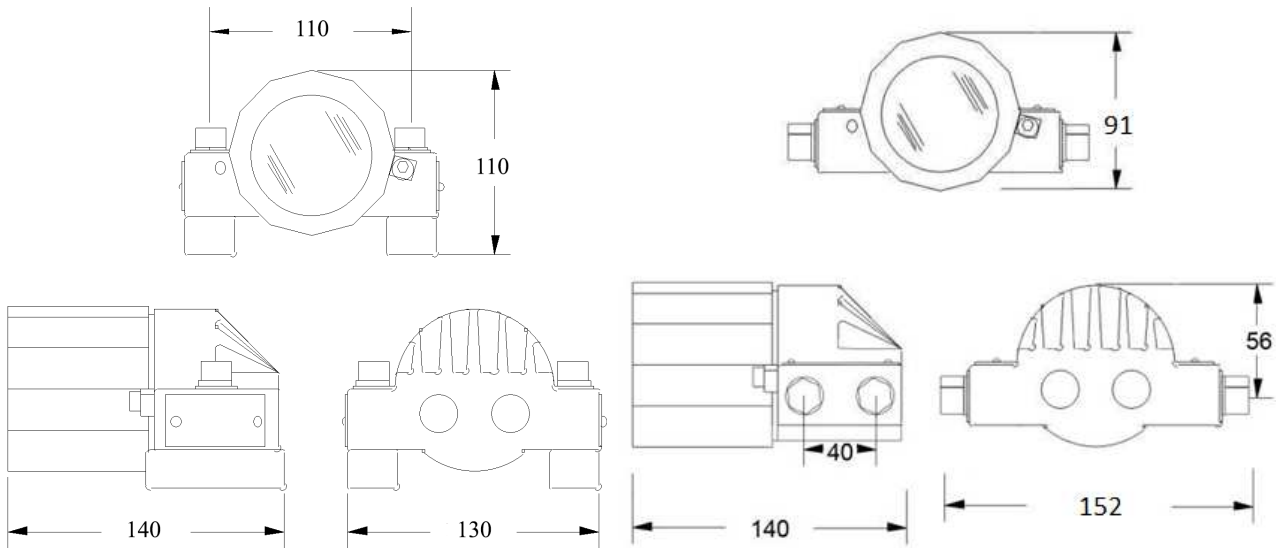

Mesurement tolerances +- 2mm

NOTE

To request a detailed Technical Specification Datasheet please contact

admin@maesa.co.za

• Application

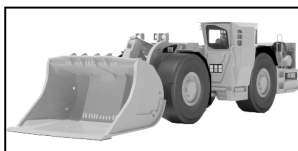

LHD LOADER

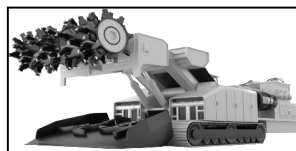

CONTINUOUS



HAULAGE



LHD DUMP TRUCK

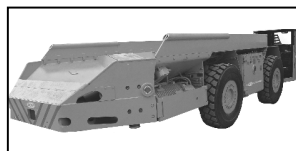

SHUTTLE CAR



GENERAL MINING VEHICLES

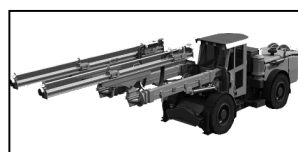

DRILLS



LONGWALL SHIELD

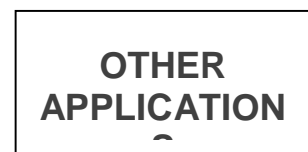

OTHER APPLICATION



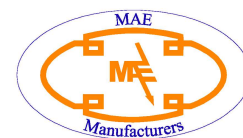

• Summary

The MAE Flameproof Side Mount LED Headlight incorporates multiple functions. It is compact and robust in design, low maintenance required, and is suitable for hazardous environment zone **Ex d I Mb**.

This alternator is certified with the following global approvals:

- ❖ ANZEx (Australia)
- ❖ IECEX (South Africa) EXPLOLABS
- ❖ CML/ATEX (Europe)

• Disclaimer

The information in this specification is derived from the latest model available at the time of issue 1.0. While every precaution has been taken to ensure the accuracy of the content, no responsibility can be accepted for any errors or omissions nor any misinterpretation or misapplication. MAE has adopted a continuous product improvement policy and therefore, specifications are subject to change without prior notice © September 2009 MAE all rights reserved.

Address: 23 Kemston Avenue,
Benoni
1501
Gauteng
South Africa

Tel: +27 011 421 5551
Fax: +27 011 421 5618
Email: orders@maesa.co.za
admin@maesa.co.za
sales@maesa.co.za

M-004-08-02

MAE Flameproof LED Headlight